

1W High Power LED

Features

- Highest flux per LED family in the world
- Very long operating life (up to 100k hours)
- Available in Red, Yellow, Green, Blue, White
- Lambertian radiation pattern
- More energy efficient than incandescent and most halogen lamps
- Low voltage DC operated
- Cool beam, safe to the touch
- Fully dimmable
- No UV
- Superior ESD protection
- lower Rth
- RoHS compliant — Lead-free
- Instant light (less than 100ns)



1W Blue LED

Applications

- Portable (flashlight, bicycle)
- Reading lights (car, bus, aircraft)
- Orientation
- Mini-accent
- Decorative
- Fiber optic alternative
- Appliance
- Sign and channel letter
- Architectural detail
- Cove lighting
- Automotive exterior (Stop-Tail-Turn,CHMSL,Mirror side repeat)
- Edge lit signs (Exit, point of sale)

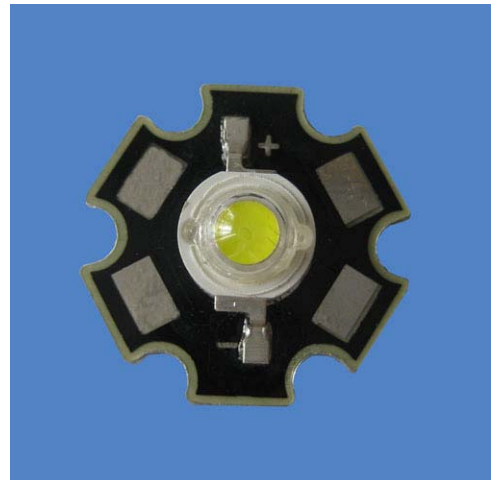

1W White LED & Aluminum PCB

Catalog

| | |
|------------------------------------|----|
| 1. Red 1W High Power LED | 2 |
| 2. Yellow 1W High Power LED..... | 4 |
| 3. Green 1W High Power LED | 7 |
| 4. Blue 1W High Power LED | 9 |
| 5. White 1W High Power LED | 12 |
| Package Dimensions (unit:mm) | 14 |

1. Red 1W High Power LED

| PART NO | Chip | | Lens Color |
|--------------|----------|---------------|-------------|
| | Material | Emitted Color | |
| LED-P1-D-Red | GaAlInP | Red ■ | WATER CLEAR |

Absolute Maximum Ratings (Ta = 25°C)

| Items | Symbol | Absolute Maximum Rating | Unit |
|-----------------------------|--------|--------------------------|------|
| Forward Current | IF | 0.35 | A |
| Peak Forward Current* | IFP | 0.8 | A |
| Reverse Voltage | VR | 5 | V |
| Power Dissipation | PD | 1 | W |
| Electrostatic discharge | ESD | ±2000 | V |
| Operation Temperature | TOPR | -40~+80 | °C |
| Storage Temperature | TSTG | -40~+100 | °C |
| Lead Soldering Temperature* | TSOL | Max. 260°C for 3sec Max. | |

*IFP Conditions: Pulse Width≤10msec duty≤1/10

* Our MCPCB is usual use for installation and connection during application, but the ability of heat dissipation is not enough. If lighted, our high power stars will need better another type heat dissipation equipment. So we recommend the working time is not over 5 -10 seconds without any heat dissipation equipment.

*Reflow, wave peak and soak stannum soldering etc. is not suitable for this products.

*Suggest to solder it by professional high power LED soldering machine.

*Can use in variable temperature searing iron with soldering condition :≤260 degree less than 3 seconds.

Typical Electrical & Optical Characteristics (Ta = 25°C)

| Items | Symbol | Condition | Min. | Typ. | Max. | Unit |
|---------------------------|--------|-----------|------|------|------|------|
| Forward Voltage | VF | IF=0.35A | 2.0 | | 2.6 | V |
| Reverse Current | IR | VR=5V | | | 50 | uA |
| 50% Power Angle | 2θ1/2 | IF=0.35A | 110 | | 140 | deg |
| Luminous Intensity | φV | IF=0.35A | 20 | | 50 | lm |
| Recommend Forward Current | IF | | | 0.35 | | A |
| Wave Length | λd | IF=0.35A | 620 | | 630 | nm |

Notes:1.Tolerance of measurement of forward voltage ±0.1V.

2.Tolerance of measurement of peak Wavelength ±2.0nm.

3.Tolerance of measurement of luminous intensity ±15%.

Typical Electrical/Optical Characteristics Curves (Ta=25° Unless Otherwise Noted)

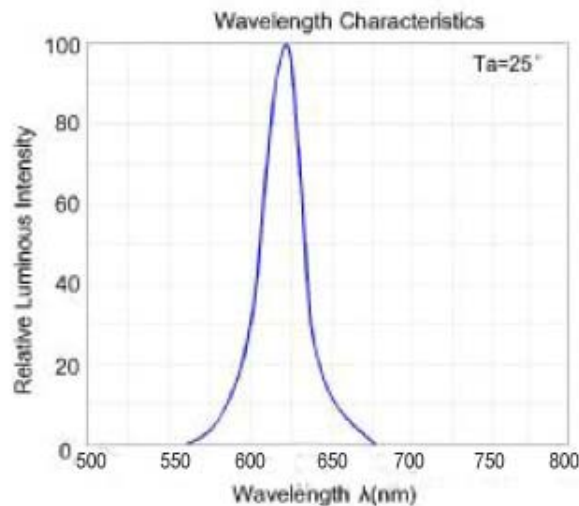
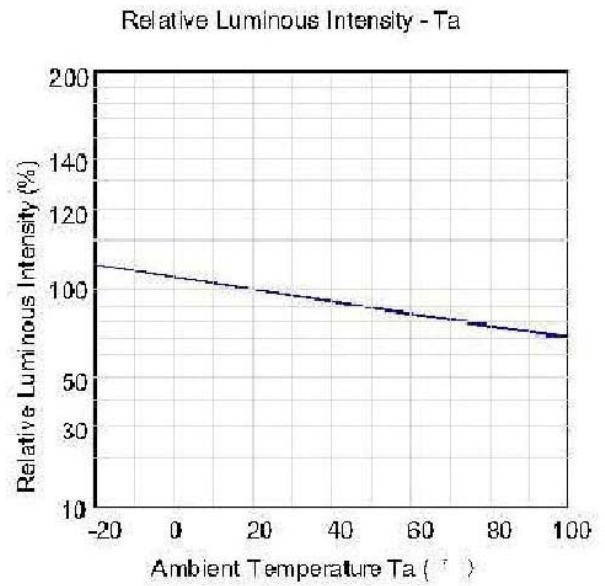
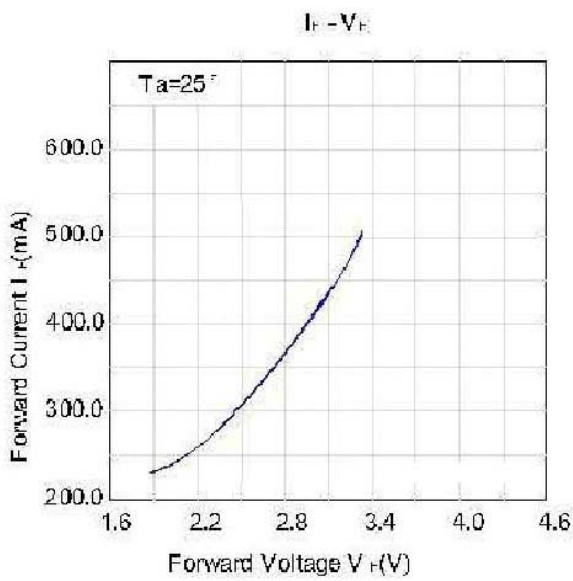
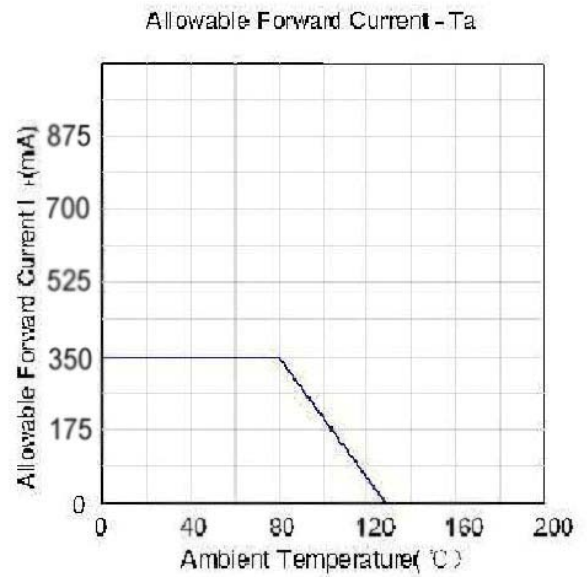
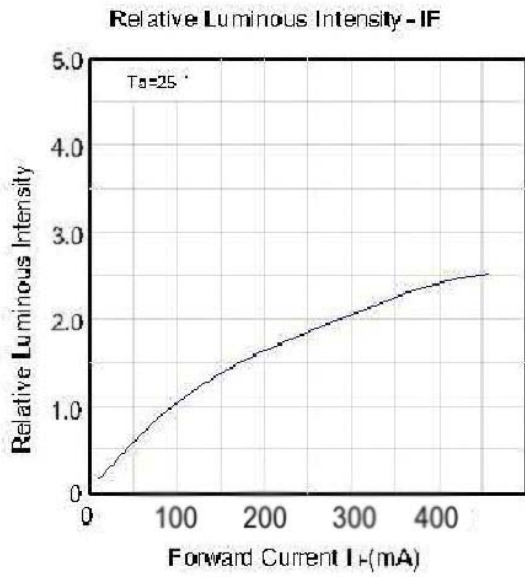

Radiation Pattern

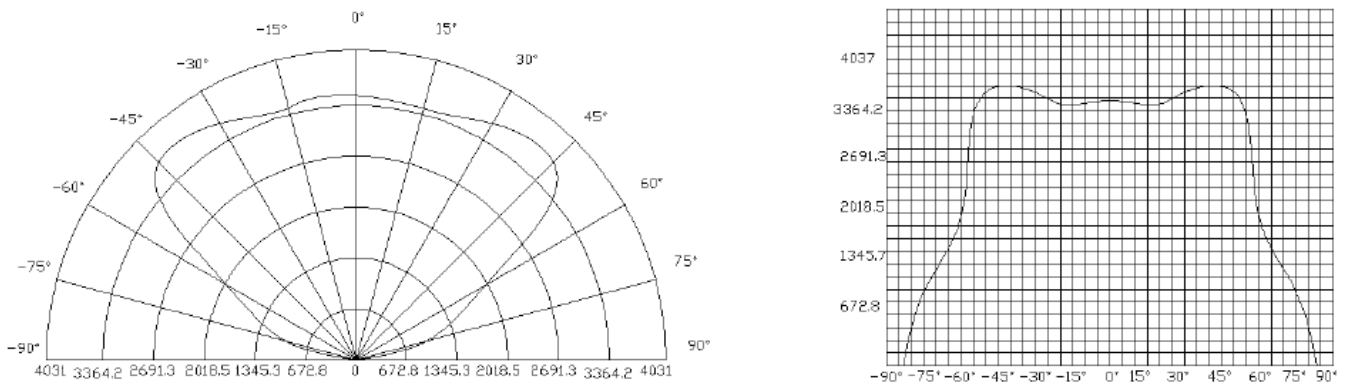

2. Yellow 1W High Power LED

| PART NO | Chip | | Lens Color |
|-----------------|----------|--|-------------|
| | Material | Emitted Color | |
| LED-P1-D-Yellow | GaAlInP | Yellow ■ | WATER CLEAR |

Absolute Maximum Ratings (Ta = 25°C)

| Items | Symbol | Absolute Maximum Rating | Unit |
|-----------------------------|--------|--------------------------|------|
| Forward Current | IF | 0.35 | A |
| Peak Forward Current* | IFP | 0.8 | A |
| Reverse Voltage | VR | 5 | V |
| Power Dissipation | PD | 1 | W |
| Electrostatic discharge | ESD | ±2000 | V |
| Operation Temperature | TOPR | -40~+80 | °C |
| Storage Temperature | TSTG | -40~+100 | °C |
| Lead Soldering Temperature* | TSOL | Max. 260°C for 3sec Max. | |

*IFP Conditions: Pulse Width≤10msec duty≤1/10

* Our MCPCB is usual use for installation and connection during application, but the ability of heat dissipation is not enough. If lighted, our high power stars will need better another type heat dissipation equipment. So we recommend the working time is not over 5 -10 seconds without any heat dissipation equipment.

*Reflow, wave peak and soak stannum soldering etc. is not suitable for this products.

*Suggest to solder it by professional high power LED soldering machine.

*Can use in variable temperature searing iron with soldering condition :≤260 degree less than 3 seconds.

Typical Electrical & Optical Characteristics (Ta = 25°C)

| Items | Symbol | Condition | Min. | Typ. | Max. | Unit |
|---------------------------|--------|-----------|------|------|------|------|
| Forward Voltage | VF | IF=0.35A | 2.0 | | 2.6 | V |
| Reverse Current | IR | VR=5V | | | 50 | uA |
| 50% Power Angle | 2θ1/2 | IF=0.35A | 110 | | 140 | deg |
| Luminous Intensity | φV | IF=0.35A | 20 | | 50 | lm |
| Recommend Forward Current | IF | | | 0.35 | | A |
| Wave Length | λd | IF=0.35A | 580 | | 595 | nm |

Notes: 1. Tolerance of measurement of forward voltage $\pm 0.1V$.

2. Tolerance of measurement of peak Wavelength $\pm 2.0nm$.

3. Tolerance of measurement of luminous intensity $\pm 15\%$.

Typical Electrical/Optical Characteristics Curves (Ta=25° Unless Otherwise Noted)

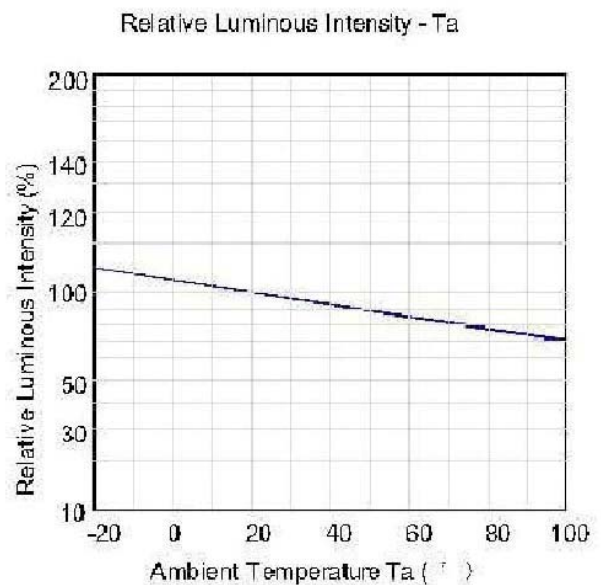
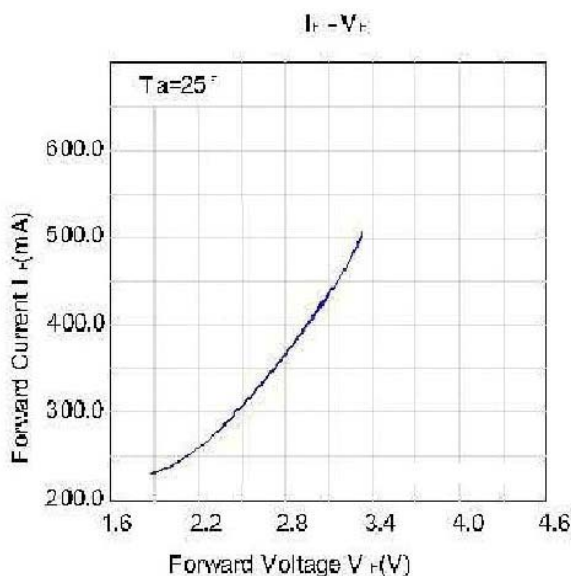
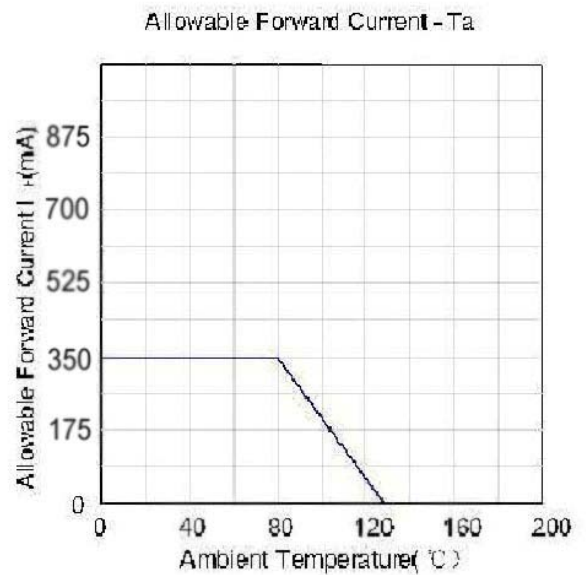
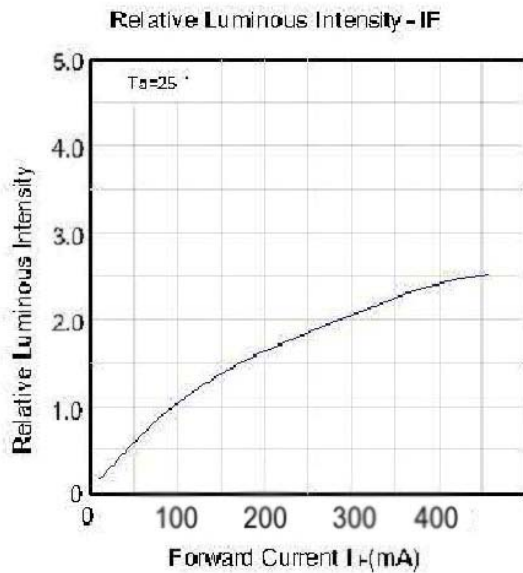

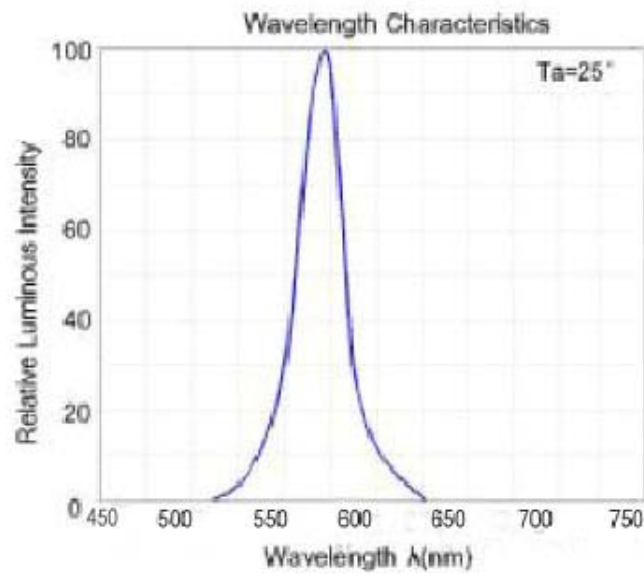

Radiation Pattern

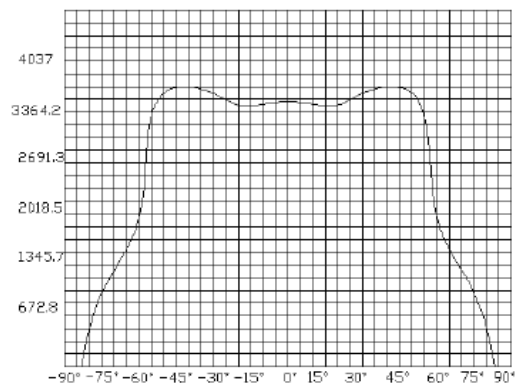
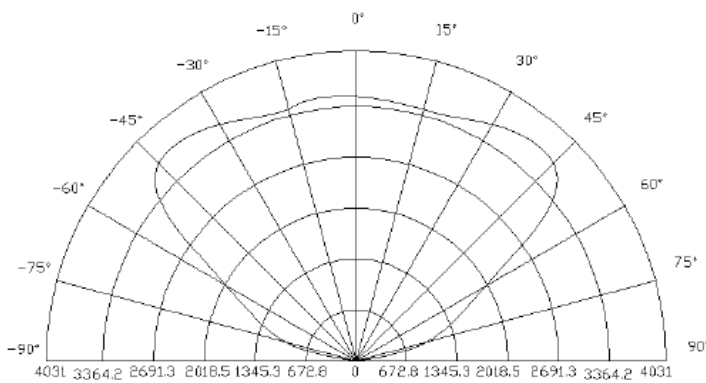

3. Green 1W High Power LED

| PART NO | Chip | | Lens Color |
|----------------|----------|---------------|-------------|
| | Material | Emitted Color | |
| LED-P1-D-Green | InGaN | Green ■ | WATER CLEAR |

Absolute Maximum Ratings (Ta = 25°C)

| Items | Symbol | Absolute Maximum Rating | Unit |
|-----------------------------|--------|--------------------------|------|
| Forward Current | IF | 0.35 | A |
| Peak Forward Current* | IFP | 0.8 | A |
| Reverse Voltage | VR | 5 | V |
| Power Dissipation | PD | 1 | W |
| Electrostatic discharge | ESD | ±2000 | V |
| Operation Temperature | TOPR | -40~+80 | °C |
| Storage Temperature | TSTG | -40~+100 | °C |
| Lead Soldering Temperature* | TSOL | Max. 260°C for 3sec Max. | |

*IFP Conditions: Pulse Width≤10msec duty≤1/10

* Our MCPCB is usual use for installation and connection during application, but the ability of heat dissipation is not enough. If lighted, our high power stars will need better another type heat dissipation equipment. So we recommend the working time is not over 5 -10 seconds without any heat dissipation equipment.

*Reflow, wave peak and soak stannum soldering etc. is not suitable for this products.

*Suggest to solder it by professional high power LED soldering machine.

*Can use in variable temperature searing iron with soldering condition :≤260 degree less than 3 seconds.

Typical Electrical & Optical Characteristics (Ta = 25°C)

| Items | Symbol | Condition | Min. | Typ. | Max. | Unit |
|---------------------------|--------|-----------|------|------|------|------|
| Forward Voltage | VF | IF=0.35A | 3.0 | | 3.6 | V |
| Reverse Current | IR | VR=5V | | | 50 | uA |
| 50% Power Angle | 2θ1/2 | IF=0.35A | 110 | | 140 | deg |
| Luminous Intensity | φV | IF=0.35A | 60 | | 80 | lm |
| Recommend Forward Current | IF | | | 0.35 | | A |
| Wave Length | λd | IF=0.35A | 520 | | 530 | nm |

Notes:1.Tolerance of measurement of forward voltage ±0.1V.

2.Tolerance of measurement of peak Wavelength ±2.0nm.

3.Tolerance of measurement of luminous intensity ±15%.

Typical Electrical/Optical Characteristics Curves (Ta=25° Unless Otherwise Noted)

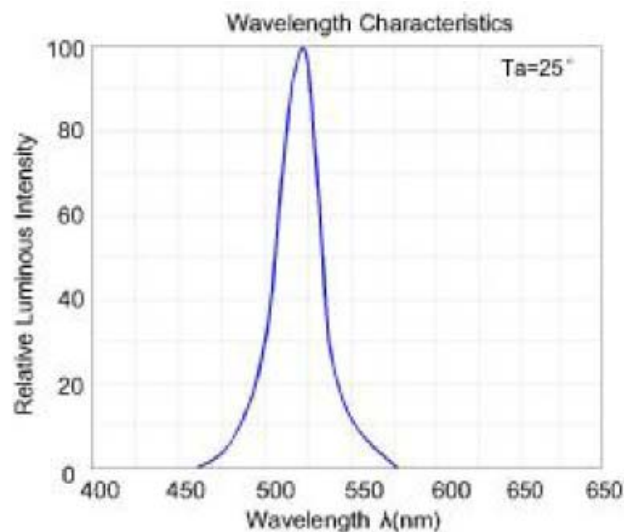
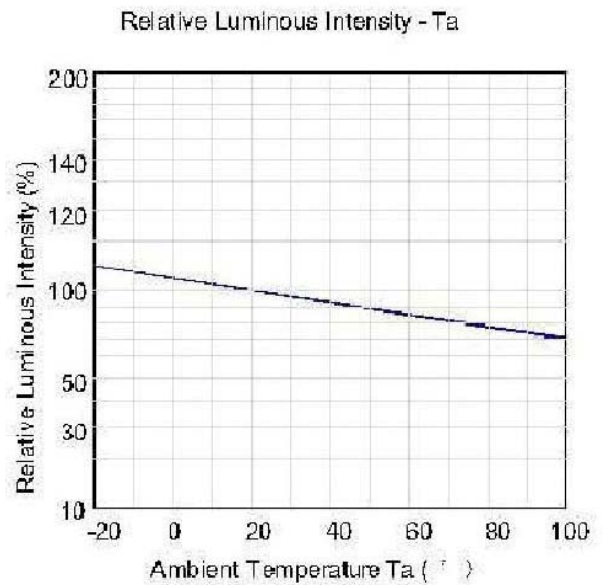
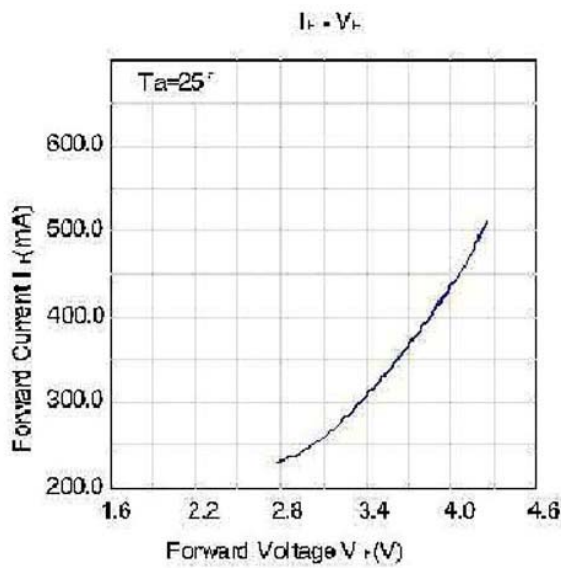
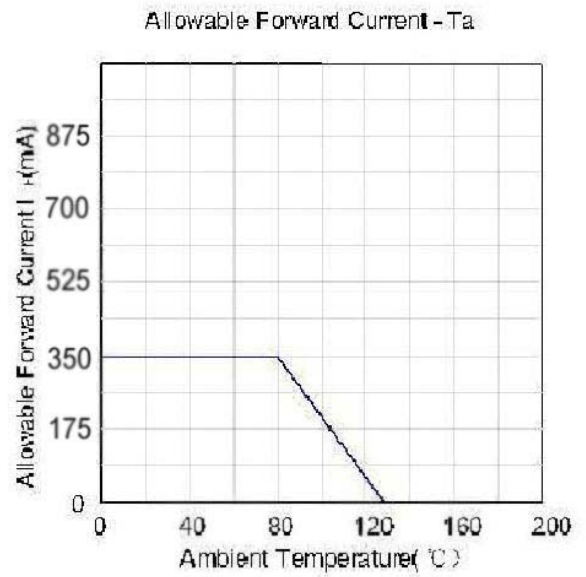
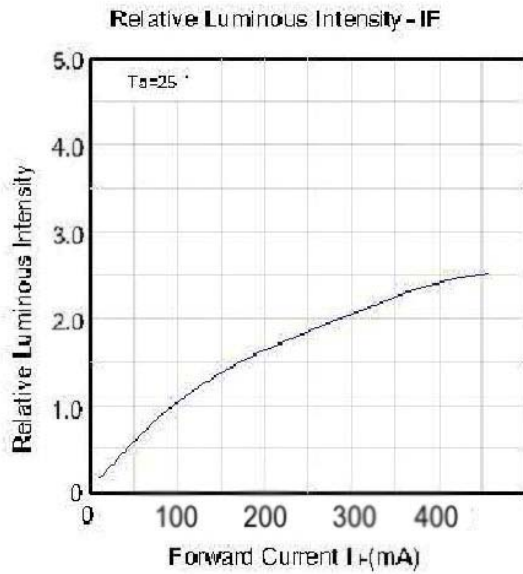

Radiation Pattern

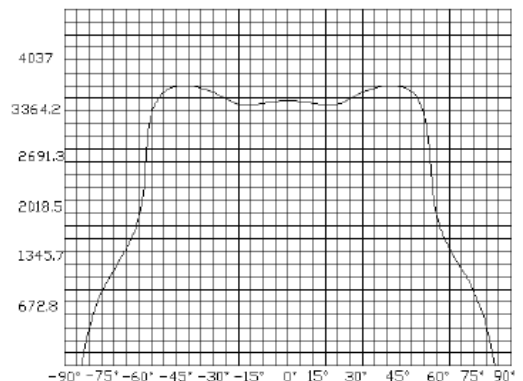
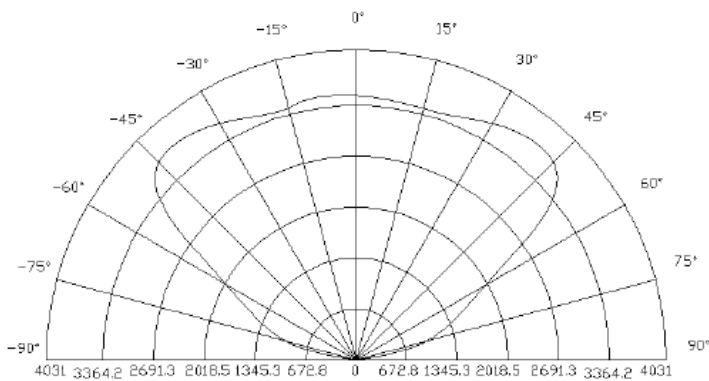

4. Blue 1W High Power LED

| PART NO | Chip | | Lens Color |
|---------------|----------|---------------|-------------|
| | Material | Emitted Color | |
| LED-P1-D-Blue | InGan | Blue ■ | WATER CLEAR |

Absolute Maximum Ratings (Ta = 25°C)

| Items | Symbol | Absolute Maximum Rating | Unit |
|-----------------------------|--------|--------------------------|------|
| Forward Current | IF | 0.35 | A |
| Peak Forward Current* | IFP | 0.8 | A |
| Reverse Voltage | VR | 5 | V |
| Power Dissipation | PD | 1 | W |
| Electrostatic discharge | ESD | ±2000 | V |
| Operation Temperature | TOPR | -40~+80 | °C |
| Storage Temperature | TSTG | -40~+100 | °C |
| Lead Soldering Temperature* | TSOL | Max. 260°C for 3sec Max. | |

*IFP Conditions: Pulse Width≤10msec duty≤1/10

* Our MCPCB is usual use for installation and connection during application, but the ability of heat dissipation is not enough. If lighted, our high power stars will need better another type heat dissipation equipment. So we recommend the working time is not over 5 -10 seconds without any heat dissipation equipment.

*Reflow, wave peak and soakstannum soldering etc. is not suitable for this products.

*Suggest to solder it by professional high power LED soldering machine.

*Can use in variable temperature searing iron with soldering condition :≤260 degree less than 3 seconds.

Typical Electrical & Optical Characteristics (Ta = 25°C)

| Items | Symbol | Condition | Min. | Typ. | Max. | Unit |
|---------------------------|--------|-----------|------|------|------|------|
| Forward Voltage | VF | IF=0.35A | 3.0 | | 3.6 | V |
| Reverse Current | IR | VR=5V | | | 50 | uA |
| 50% Power Angle | 2θ1/2 | IF=0.35A | 110 | | 140 | deg |
| Luminous Intensity | φV | IF=0.35A | 10 | | 30 | lm |
| Recommend Forward Current | IF | | | 0.35 | | A |
| Wave Length | λd | IF=0.35A | 460 | | 470 | nm |

Notes: 1. Tolerance of measurement of forward voltage $\pm 0.1V$.

2. Tolerance of measurement of peak Wavelength $\pm 2.0nm$.

3. Tolerance of measurement of luminous intensity $\pm 15\%$.

Typical Electrical/Optical Characteristics Curves (Ta=25° Unless Otherwise Noted)

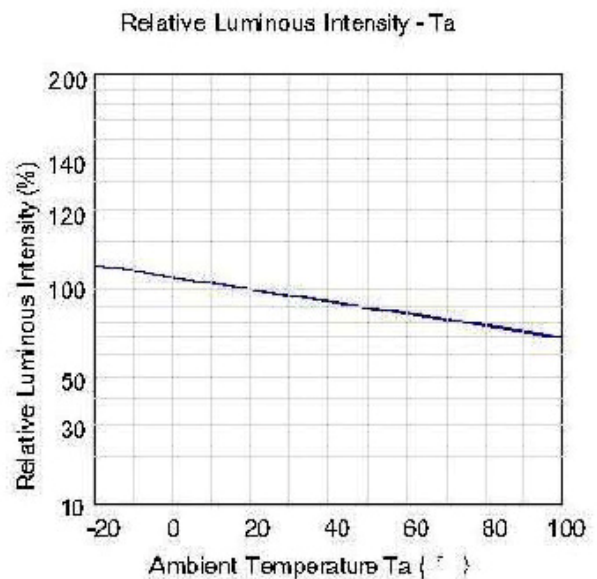
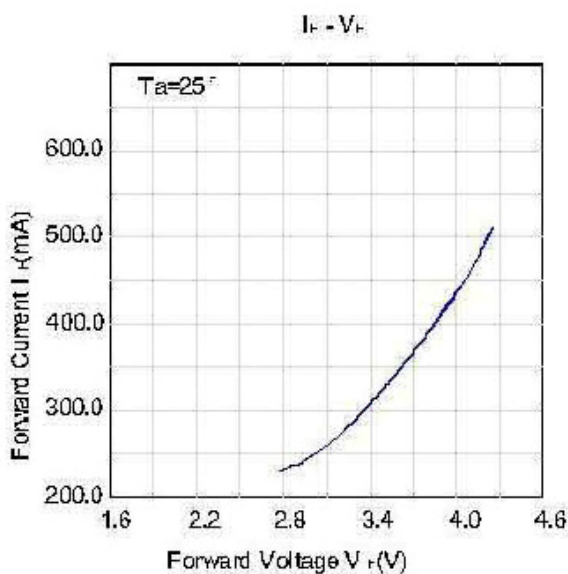
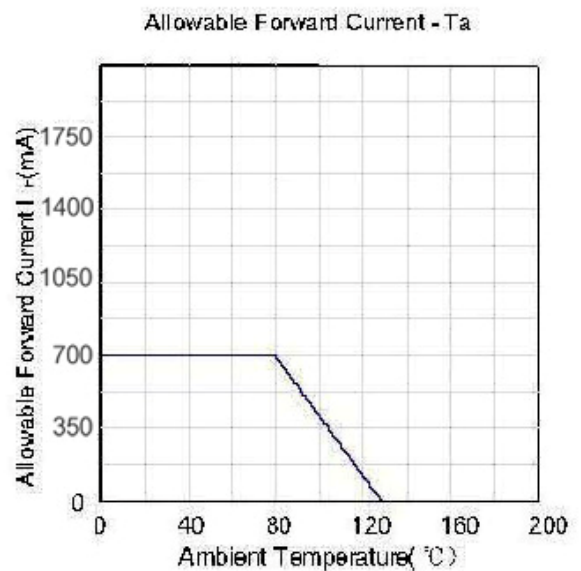
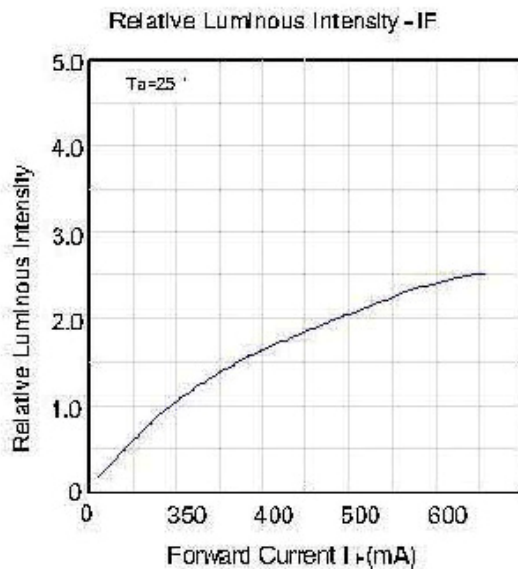

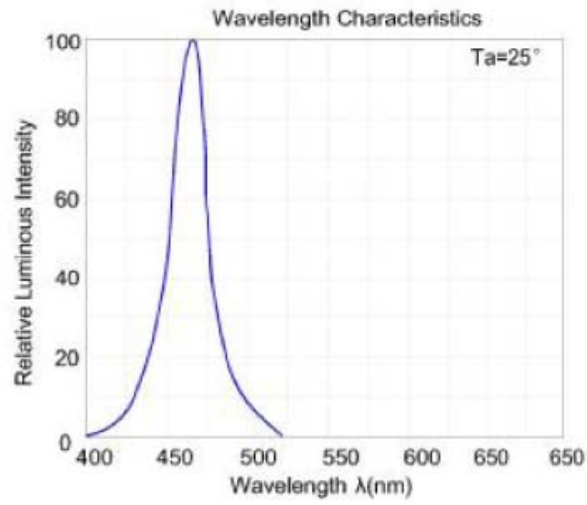

Radiation Pattern

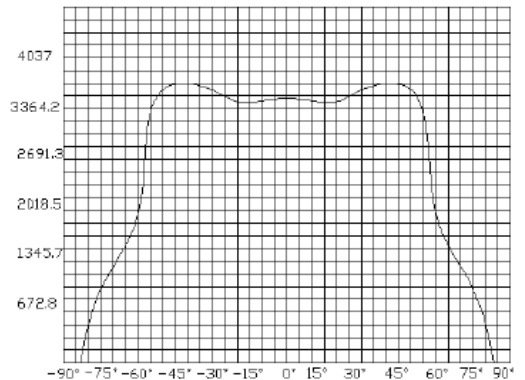
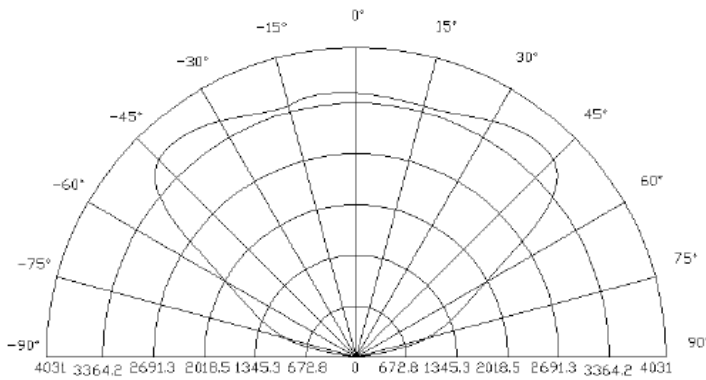

5. White 1W High Power LED

| PART NO | Chip | | Lens Color |
|----------------|----------|---------------|-------------|
| | Material | Emitted Color | |
| LED-P1-D-White | InGaN | White □ | WATER CLEAR |

Absolute Maximum Ratings (Ta = 25°C)

| Items | Symbol | Absolute Maximum Rating | Unit |
|-----------------------------|--------|--------------------------|------|
| Forward Current | IF | 0.35 | A |
| Peak Forward Current* | IFP | 0.8 | A |
| Reverse Voltage | VR | 5 | V |
| Power Dissipation | PD | 1 | W |
| Electrostatic discharge | ESD | ±4500 | V |
| Operation Temperature | TOPR | -40~+80 | °C |
| Storage Temperature | TSTG | -40~+100 | °C |
| Lead Soldering Temperature* | TSOL | Max. 260°C for 3sec Max. | |

*IFP Conditions: Pulse Width≤10msec duty≤1/10

* Our MCPCB is usual use for installation and connection during application, but the ability of heat dissipation is not enough. If lighted, our high power stars will need better another type heat dissipation equipment. So we recommend the working time is not over 5 -10 seconds without any heat dissipation equipment.

*Reflow, wave peak and soakstannum soldering etc. is not suitable for this products.

*Suggest to solder it by professional high power LED soldering machine.

*Can use in variable temperature searing iron with soldering condition :≤260 degree less than 3 seconds.

Typical Electrical & Optical Characteristics (Ta = 25°C)

| Items | Symbol | Condition | Min. | Typ. | Max. | Unit |
|--------------------------------------|--------|-----------|------|------|------|------|
| Forward Voltage | VF | IF=0.35A | 3.2 | | 3.6 | V |
| Reverse Current | IR | VR=5V | | | 50 | uA |
| 50% Power Angle | 2θ1/2 | IF=0.35A | 110 | | 140 | deg |
| Luminous Intensity | φV | IF=0.35A | 100 | | 110 | lm |
| Recommend Forward Current | IF | | | 0.35 | | A |
| Chromaticity | Tc | IF=0.35A | 6000 | | 6500 | k |
| White Color Region | -- | | | | | |
| Chromaticity Coordinates | X=-- | | Y=-- | | | |
| Thermal Resistance, Junction to Case | RJP | IF=0.35A | | 10 | | °C/W |

Notes:1.Tolerance of measurement of forward voltage ±0.1V.

2.Tolerance of measurement of peak Wavelength ±2.0nm.

3.Tolerance of measurement of luminous intensity ±15%.

Typical Electrical/Optical Characteristics Curves (Ta=25° Unless Otherwise Noted)

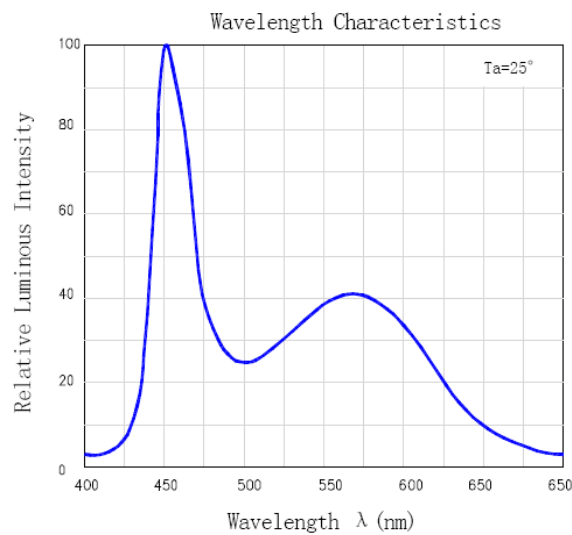
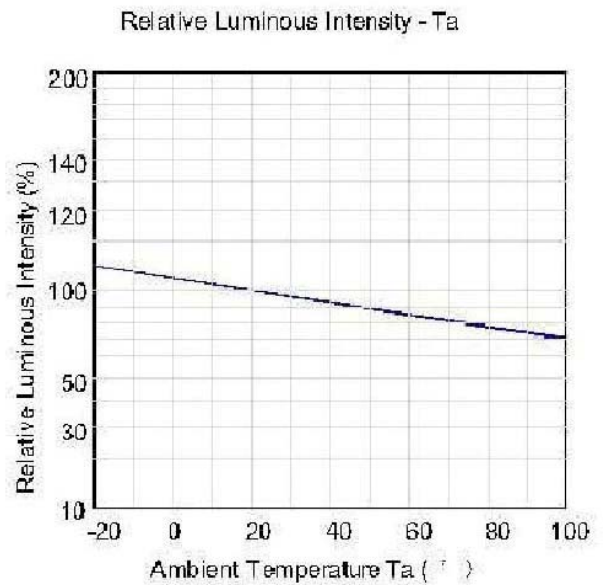
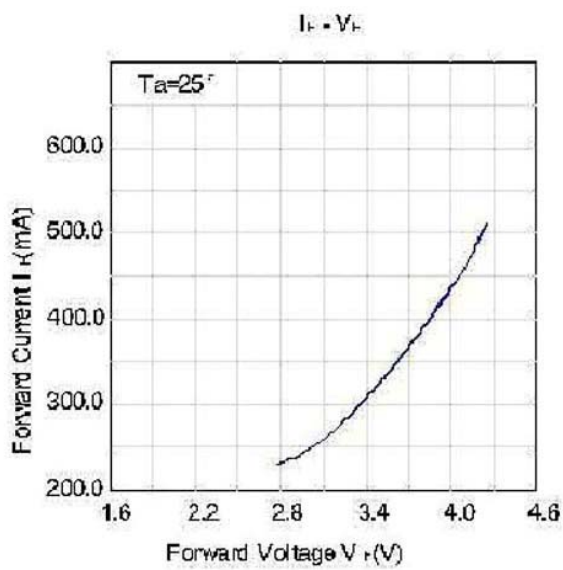
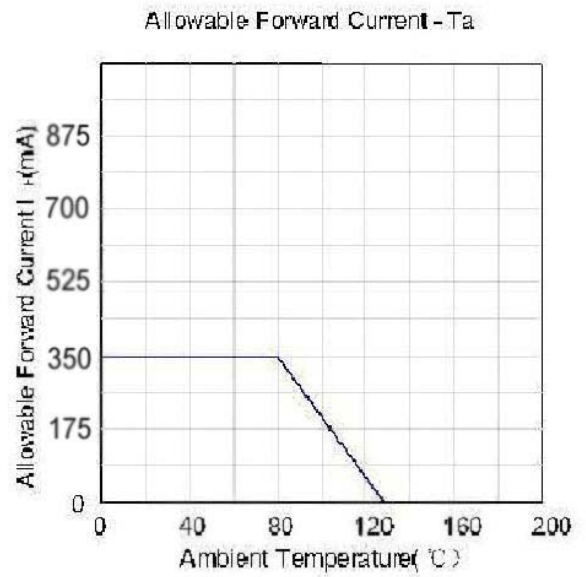
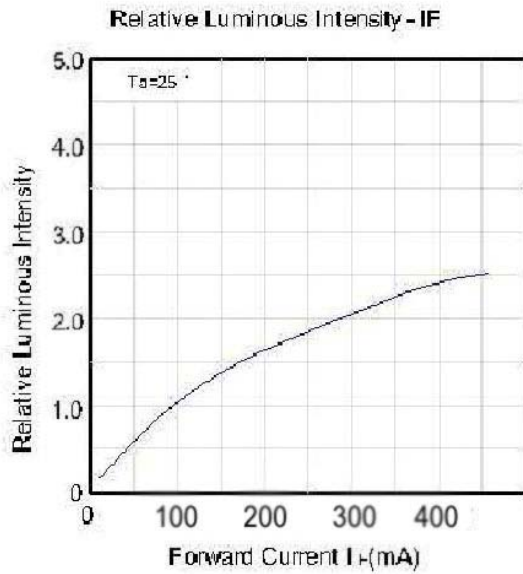

Radiation Pattern

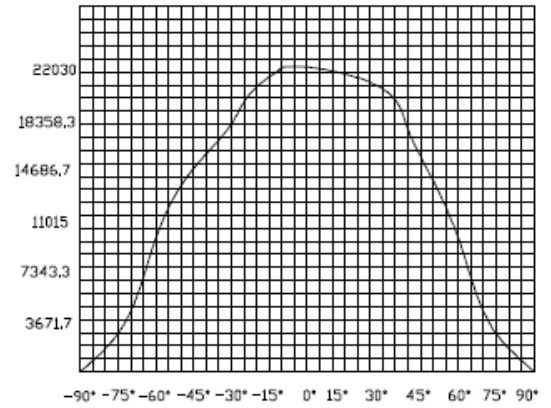
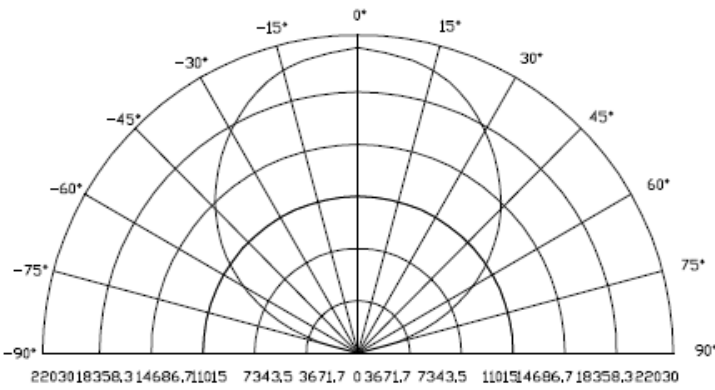

Package Dimensions (unit:mm)

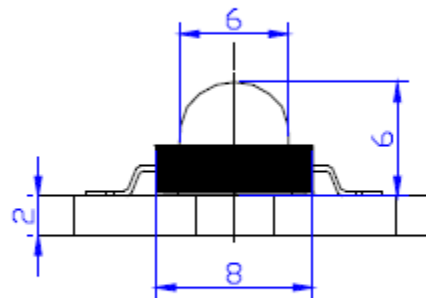
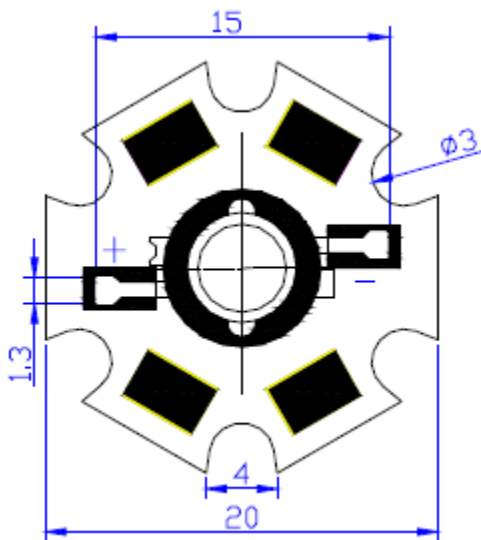

Notes:

All dimensions in mm tolerance is $\pm 0.2\text{mm}$ unless otherwise noted.